

RVU6525

LAUNDRY WASHBOARD SINK

RUVATI[®]
SPECIFICATION SHEET

MATERIAL

True 16 Gauge Thickness
Premium T304 Grade Stainless Steel
18/10 Chromium/Nickel Content
Commercial Brushed Finish

FEATURES

- Heavy duty sound guard padding and undercoating
- Slanted bottom with elegant drain grooves for easy draining
- Dual-Tier Ledge for Accessories

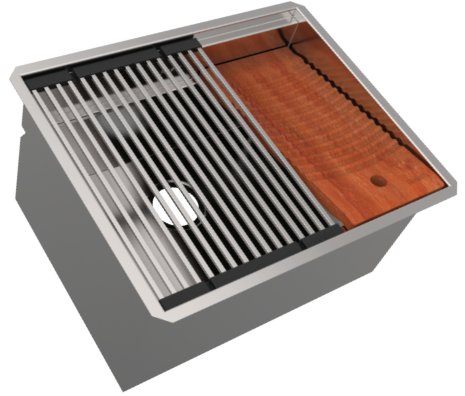

IN THE BOX

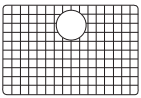

Rinse Grid
[RVA68308]

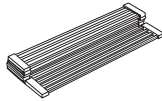

Folding Rack
[RVA1395]



Cut-out
Template



Strainer
[RVA1022ST]



Drain Cover
[RVA1035]

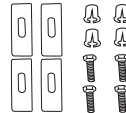

Mounting Clips
[RVA11031]



Washboard
[RVA1253MG]

NOMINAL DIMENSIONS

Exterior: 23" (wide) x 19" (front-to-back)
Interior Bowl: 21-7/16" (wide) x 15-7/16" (front-to-back)
Bowl Depth: 12"
Minimum Cabinet Size: 25" wide
Drain Hole Size: 3-1/2"

Installation Type:

Undermount

Inside Corners:

Rounded

Drain Location:

Rear Center

RUVATI USA

www.ruvati.com

Phone: 1.855.478.8284
Email: support@ruvati.com

OPTIONAL ACCESSORIES (SOLD SEPARATELY)



Deep Basket
Disposal Flange
[RVA1049ST]

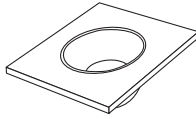

Mixing Bowl
and Platform
[RVA1288]

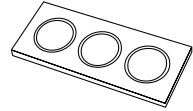

Condiment
Serving Tray
[RVA1377]

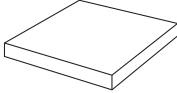

Butcher Block
[RVA2445ACA]

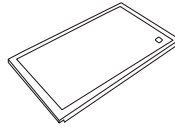

Black Plastic
Cutting Board
[RVA1217BLK]

RUVATI

DIMENSIONS

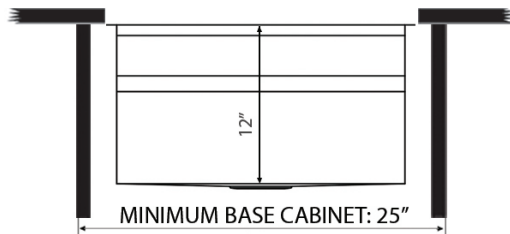
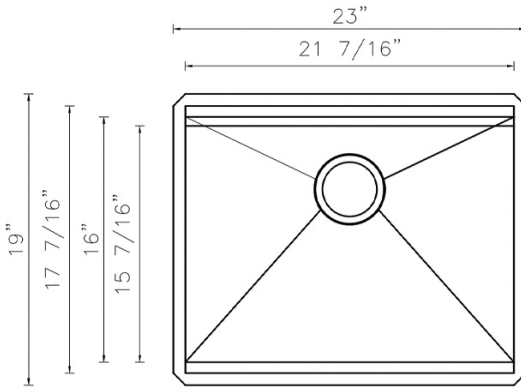

Register your product at www.ruvati.com/register.