

# RVM5228

TOPMOUNT KITCHEN SINK

**RUVATI**<sup>®</sup>  
SPECIFICATION SHEET

## MATERIAL

True 16 Gauge Thickness  
Premium T304 Grade Stainless Steel  
18/10 Chromium/Nickel Content  
Commercial Brushed Finish

## FEATURES

- Heavy duty sound guard padding and undercoating
- Curved bowl and rounded bottom for perfect drainage
- Large deep bowl

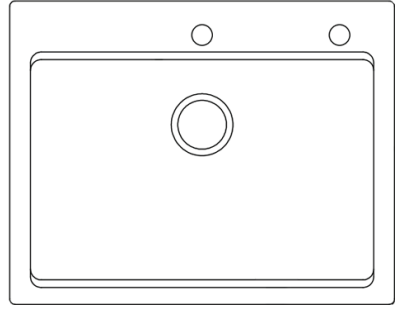

## IN THE BOX



Basket Strainer  
[RVA1025]

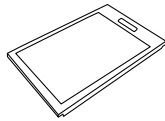

Cutting Board  
[RVA1230BAM]

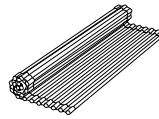

Roll-Up Rack  
[RVA1398]

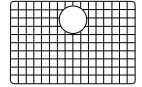

Rinse Grid  
[RVA65025]

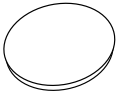

Drain Cover  
[RVA1035]

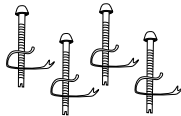

Mounting Clips  
[RVA11044]



Cut-out  
Template

## NOMINAL DIMENSIONS

Exterior: 28" (wide) x 22" (front-to-back)  
Interior Bowl: 25" (wide) x 16" (front-to-back)  
Bowl Depth: 9"  
Minimum Cabinet Size: 30" wide  
Drain Hole Size: 3½"

Installation Type:  
Topmount  
Inside Corners:  
Rounded  
Drain Location:  
Rear Center

**RUVATI USA**

www.ruvati.com

Phone: 1.855.478.8284  
Email: support@ruvati.com

# OPTIONAL ACCESSORIES (SOLD SEPARATELY)



Deep Basket  
Disposal Flange  
[RVA1049ST]



Deep Basket  
Disposal Flange/Stopper  
[RVA1052ST]



Garbage Disposal  
Flange/Stopper  
[RVA1042ST]



Deep Basket Strainer  
and Stopper  
[RVA1027ST]

## DIMENSIONS

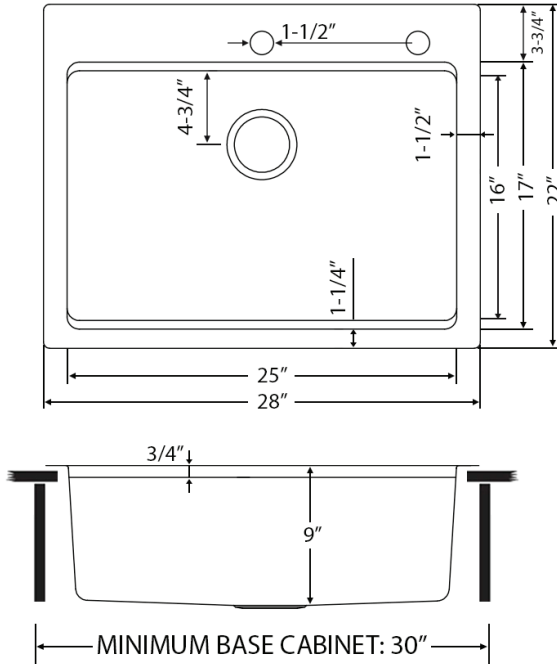

cUPC certified by IAPMO  
to meet US and Canada  
plumbing standards.



**SCAN TO REGISTER  
YOUR WARRANTY**

or visit  
[ruvati.com/register](http://ruvati.com/register)

# RUVATI USA

[www.ruvati.com](http://www.ruvati.com)

Phone: 1.855.478.8284  
Email: [support@ruvati.com](mailto:support@ruvati.com)