

RVH8597

UNDERMOUNT SLOPE BOTTOM SINK

RUVATI[®]
SPECIFICATION SHEET

MATERIAL

True 16 Gauge Thickness
Premium T304 Grade Stainless Steel
18/10 Chromium/Nickel Content
Commercial Brushed Finish

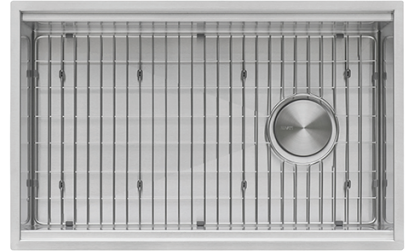

FEATURES

- Heavy duty sound guard padding and undercoating
- Slanted bottom with elegant drain grooves for easy draining
- Reversible Offset Drain with Sloped Bottom



IN THE BOX



Basket Strainer
[RVA1025]

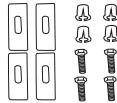

Mounting Clips
[RVA11031]



Drain Cover
[RVA1035]

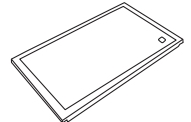

Black
Cutting Board
[RVA1217BWC]



Cut-out
Template

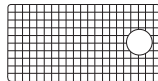

Rinse Grid
[RVA68591]

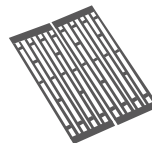

Folding Rack
[RVA1397]

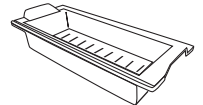

Colander
[RVA1367BLK]

NOMINAL DIMENSIONS

Exterior: 33" (wide) x 19" (front-to-back)
Interior Bowl: 31-3/8" (wide) x 16" (front-to-back)
Bowl Depth: 10"
Minimum Cabinet Size: 36" wide
Drain Hole Size: 3 1/2"

Installation Type:
Undermount

Inside Corners:
Rounded

Drain Location:
Offset

RUVATI USA

www.ruvati.com

Phone: 1.855.478.8284
Email: support@ruvati.com

OPTIONAL ACCESSORIES (SOLD SEPARATELY)



Deep Basket
Disposal Flange
[RVA1049ST]

Drain Cover
[RVA1035]

DIMENSIONS

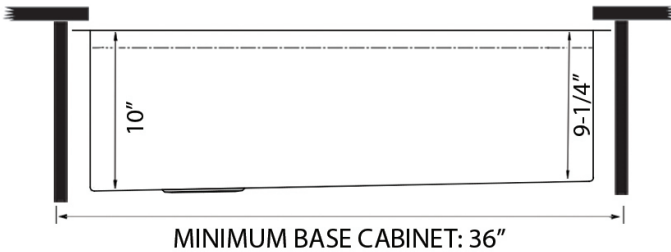
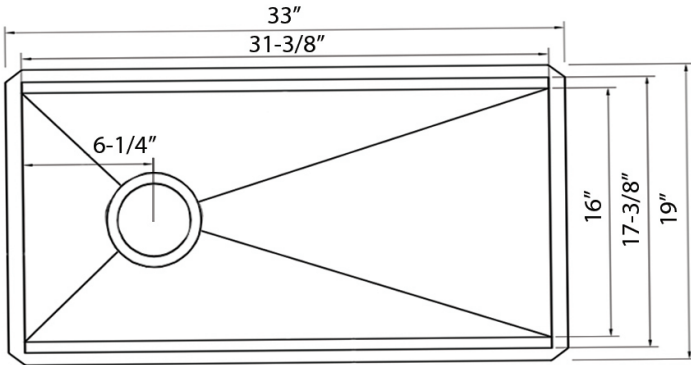

Register your product at www.ruvati.com/register.