

RVH8410

UNDERMOUNT WORKSTATION SINK

RUVATI[®]
SPECIFICATION SHEET

MATERIAL

- True 16 Gauge Thickness
- Premium T304 Grade Stainless Steel
18/10 Chromium/Nickel Content

FEATURES

- Heavy duty sound guard padding and undercoating
- Slanted bottom with elegant drain grooves for easy draining
- Rounded inside corners



COLOR OPTIONS

ST: Stainless Steel

BL: Gunmetal Black

IN THE BOX

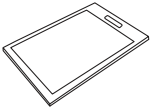

Cutting Board
[RVA1217]

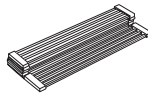

Folding Rack
[RVA1395]



Mounting Clips
[RVA11031]



Basket Strainer
[RVA1025BL/ST]



Drain Cover
[RVA1035BL/ST]



Cut-out
Template

NOMINAL DIMENSIONS

Exterior: 32" (wide) x 19" (front-to-back)

Interior Bowl: 30-1/2" (wide) x 16" (front-to-back)

Bowl Depth: 9"

Drain Hole Size: 3 1/2"

Installation Type:
Undermount

Inside Corners:
Rounded

Drain Location:
Rear Center

RUVATI USA

www.ruvati.com

Phone: 1.855.478.8284
Email: support@ruvati.com

OPTIONAL ACCESSORIES (SOLD SEPARATELY)

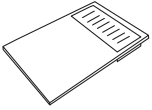

Cutting Board
[RVA1220]

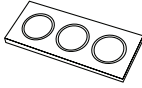

Condiment
Serving Tray
[RVA1377]



Caddy
[RVA1580]

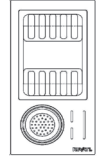

Caddy Drying Rack
[RVA1542]

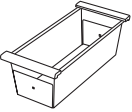

Colander
[RVA1317]



Deep Basket
Disposal Flange
[RVA1049BL/ST]



Garbage Disposal
Flange/Stopper
[RVA1042BL/ST]



Deep Basket Strainer
and Stopper
[RVA1027BL/ST]

DIMENSIONS

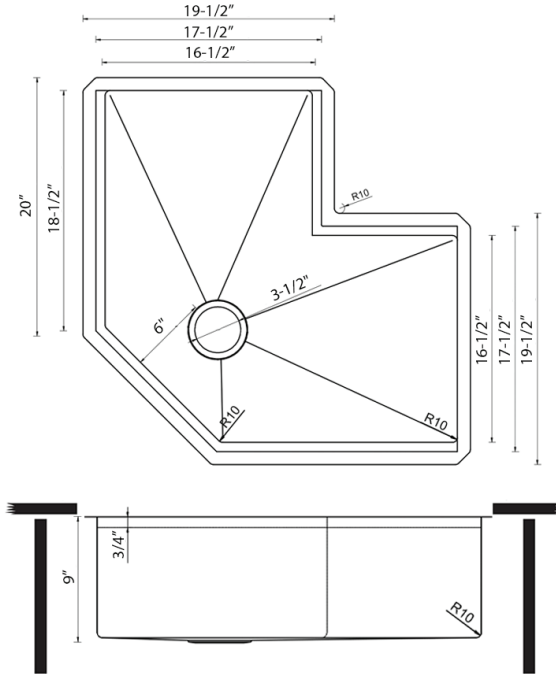

cUPC certified by IAPMO
to meet US and Canada
plumbing standards.



**SCAN TO REGISTER
YOUR WARRANTY**

or visit
ruvati.com/register

RUVATI USA

www.ruvati.com

Phone: 1.855.478.8284
Email: support@ruvati.com