

RVH8262ST

TOPMOUNT WORKSTATION BAR SINK

RUVATI[®]
SPECIFICATION SHEET

MATERIAL

True 16 Gauge Thickness
Premium T304 Grade Stainless Steel
18/10 Chromium/Nickel Content
Commercial Brushed Finish

FEATURES

- US Patent No. D1077999
- Built-in glass rinser with drying rack
- Single-Tier Ledge for Accessories
- Heavy duty sound guard padding and undercoating

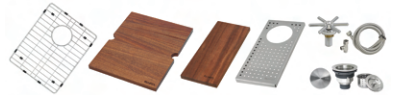

IN THE BOX

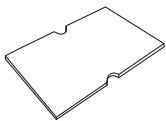

Cutting Board
[RVA1210]

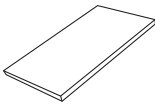

Cutting Board
[RVA1242]

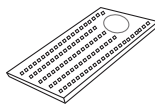

Drainer Grate
[RVA11027]

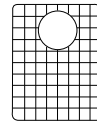

Rinse Grid
[RVA68210]



Flex Hose
[RVA11025]

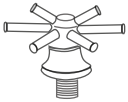

Sprayer Assembly
[RVA11026]



Basket Strainer
[RVA1025]



Drain Cover
[RVA1035]



Mounting Clips
[RVA11042]



Cut-out
Template

NOMINAL DIMENSIONS

Exterior: 22" (wide) x 20" (front-to-back)
Interior Bowl: 13" x 14 $\frac{5}{8}$ " (left), 7" x 14 $\frac{5}{8}$ " (right)
Bowl Depth: 10"
Minimum Cabinet Size: 24" wide
Drain Hole Size: 3 $\frac{1}{2}$ "

Installation Type:
Topmount
Inside Corners:
Sharp
Drain Location:
Rear Center

RUVATI USA
www.ruvati.com

Phone: 1.855.478.8284
Email: support@ruvati.com

OPTIONAL ACCESSORIES (SOLD SEPARATELY)



Deep Basket
Disposal Flange
[RVA1049ST]



Deep Basket
Disposal Flange/Stopper
[RVA1052ST]



Garbage Disposal
Flange/Stopper
[RVA1042ST]



Deep Basket Strainer
and Stopper
[RVA1027ST]

DIMENSIONS

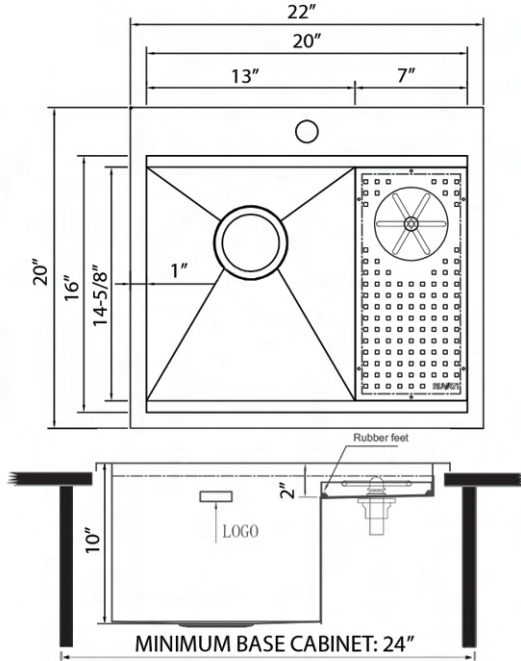

cUPC certified by IAPMO
to meet US and Canada
plumbing standards.



**SCAN TO REGISTER
YOUR WARRANTY**

or visit
ruvati.com/register

RUVATI USA
www.ruvati.com

Phone: 1.855.478.8284
Email: support@ruvati.com