

# RVH8253

UNDERMOUNT WORKSTATION SINK

**RUVATI**<sup>®</sup>  
SPECIFICATION SHEET

## MATERIAL

True 16 Gauge Thickness  
Premium T304 Grade Stainless Steel  
18/10 Chromium/Nickel Content  
Commercial Brushed Finish

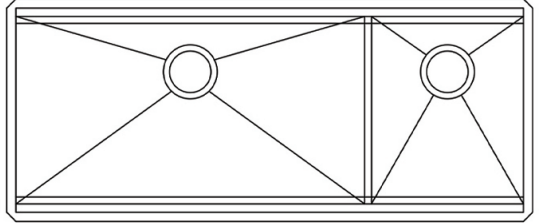

## FEATURES

- Heavy duty sound guard padding and undercoating
- Slanted bottom with elegant drain grooves for easy draining
- Dual-Tier Ledge for Accessories

## IN THE BOX

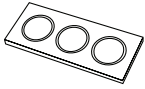

Condiment Serving Tray  
[RVA1377]

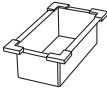

Collander  
[RVA1310]

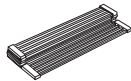

Folding Rack  
[RVA1395]

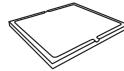

Cutting Board  
[RVA1233]



Mixing Bowl and Platform  
[RVA1288]



Basket Strainer  
[RVA1025] X2



Drain Cover  
[RVA1035] X2

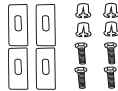

Mounting Clips  
[RVA11031]



Cut-out Template

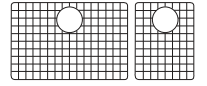

Rinse Grid  
[RVA68253]

## NOMINAL DIMENSIONS

Exterior: 45" (wide) x 19" (front-to-back)  
Interior Bowl: 43<sup>3</sup>/<sub>8</sub>" (wide) x 14<sup>7</sup>/<sub>8</sub>" (front-to-back)  
Bowl Depth: 9-7/8"  
Minimum Cabinet Size: 48" wide  
Drain Hole Size: 3<sup>1</sup>/<sub>2</sub>"

**Installation Type:**  
Undermount

**Inside Corners:**  
Zero Radius

**Drain Location:**  
Rear Center

**RUVATI USA**

www.ruvati.com

Phone: 1.855.478.8284  
Email: support@ruvati.com

## OPTIONAL ACCESSORIES (SOLD SEPARATELY)



Deep Basket  
Disposal Flange  
[RVA1049ST]

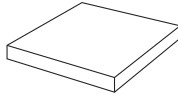

Butcher Block  
[RVA2445ACA]

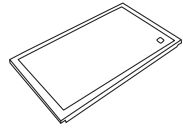

Black Plastic  
Cutting Board  
[RVA1217BLK]

## DIMENSIONS

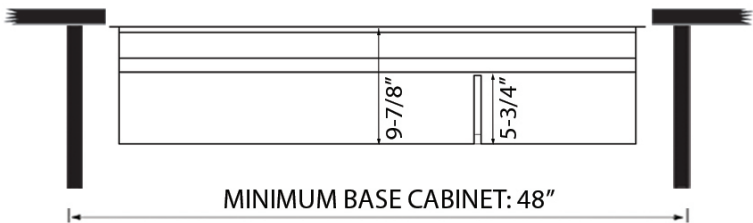
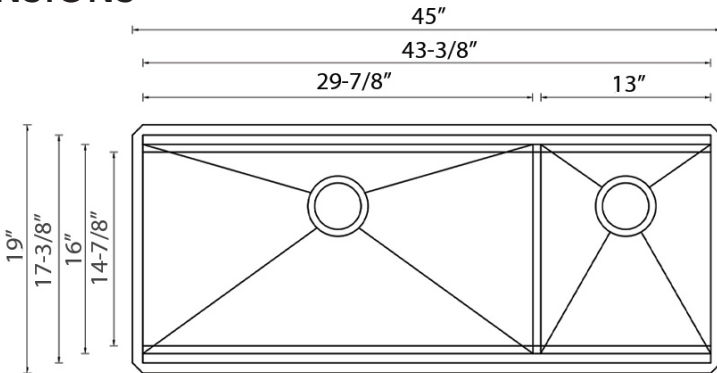

Register your product at [www.ruvati.com/register](http://www.ruvati.com/register).