

RVH8210

TOPMOUNT WORKSTATION SINK

RUVATI[®]
SPECIFICATION SHEET

MATERIAL

- True 16 Gauge Thickness
- Premium T304 Grade Stainless Steel
- Nano-PVD colored finish: easy to clean and long lasting

FEATURES

- Heavy duty sound guard padding and undercoating
- Slanted bottom with elegant drain grooves for easy draining
- Single-Tier Ledge for Accessories

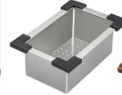
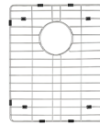

COLOR OPTIONS

BL: Black Stainless Steel

GG: Matte Gold Brass Tone

IN THE BOX

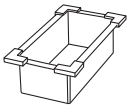

Colander
[RVA1310]

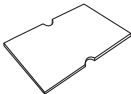

Cutting Board
[RVA1210]



Basket Strainer
[RVA1022BL/GG]



Mounting Clips
[RVA11048]

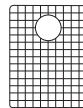

Rinse Grid
[RVA68210]



Cut-out
Template

NOMINAL DIMENSIONS

Exterior: 15" (wide) x 20" (front-to-back)
Interior Bowl: 13" (wide) x 14-1/2" (front-to-back)
Bowl Depth: 9"
Minimum Cabinet Size: 18" wide
Drain Hole Size: 3-1/2"

Installation Type:
Topmount

Inside Corners:
Rounded

Drain Location:
Rear Center

RUVATI USA

www.ruvati.com

Phone: 1.855.478.8284
Email: support@ruvati.com

OPTIONAL ACCESSORIES (SOLD SEPARATELY)

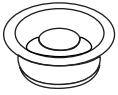

Garbage
Disposal Flange
[RVA1041BL/GG]



cUPC certified by IAPMO to meet US and Canada plumbing standards.
Codes compliance: ASME A112.19.3/CSA B45.4

DIMENSIONS

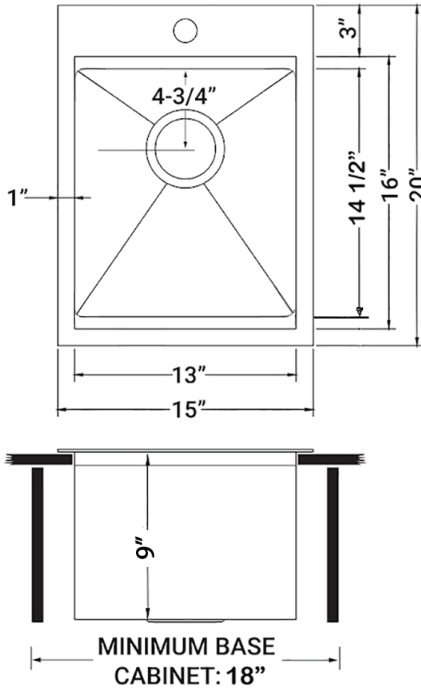

Register your product at www.ruvati.com/register.